

EXHIBITOR SPACE RULES AND SPECIFICATIONS

STANDARD OR "INLINE" (Instead of Linear) EXHIBIT SPACES

Any exhibit space that shares a common back wall and/or side with other exhibits and only one side exposed to aisle. These exhibit spaces can be purchased in a row to make a 10x20, 10x30, 10x40 etc. if the exhibitor abides by the rules below:

- Max height = 8'
- No end caps are allowed
- All display material over 5' may not extend farther out than 5' from the back of the exhibit space.
- Exhibitors are required to provide flooring for the totality of their exhibit space

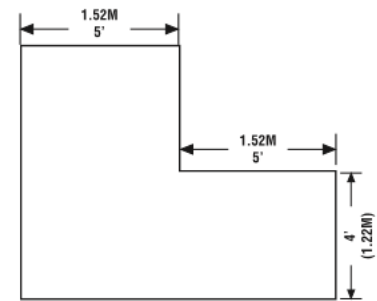
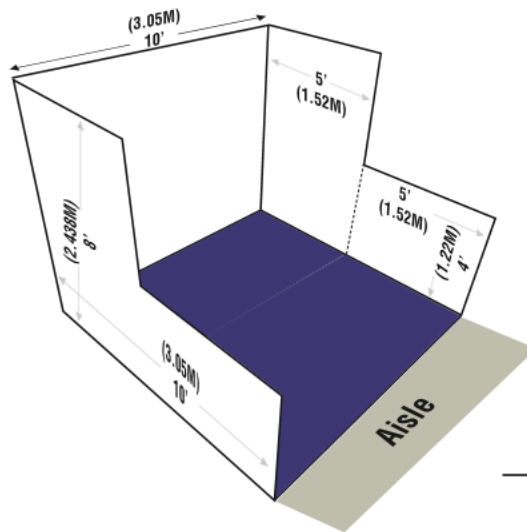
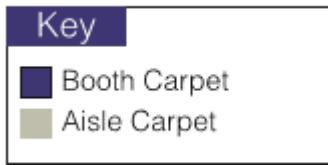

Standard Inline Exhibit Space (10x10) below:

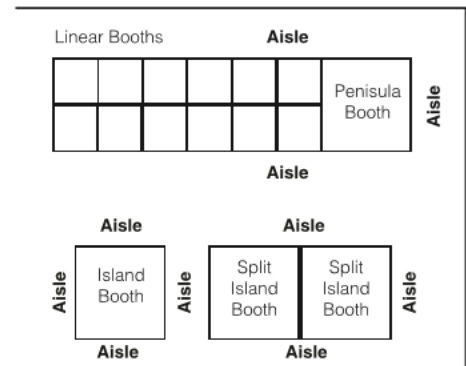
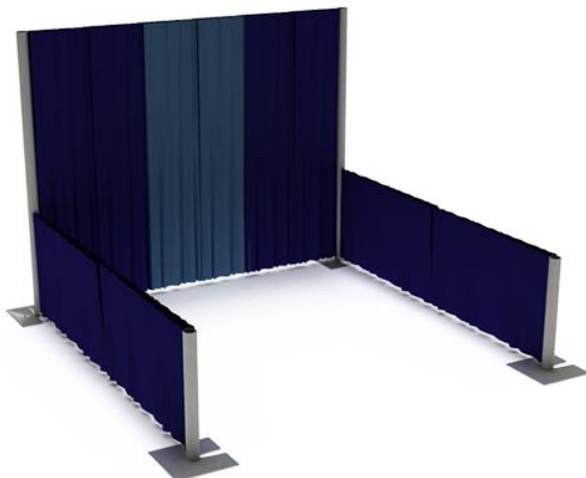

EXHIBITOR SPACE RULES AND SPECIFICATIONS

PERIMETER EXHIBIT SPACES

Perimeter exhibit spaces are located along the exhibit halls perimeter walls. These exhibit spaces can be purchased if the exhibitor abides by the rules below:

- Max height = 12'
- Hanging Signs: Not permitted
- Back walls and side walls that are visible must be finished
- Tents are allowed in perimeter exhibit spaces ONLY
- Exhibitors are required to provide flooring for the totality of their exhibit space

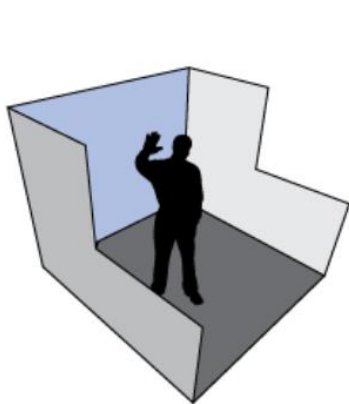
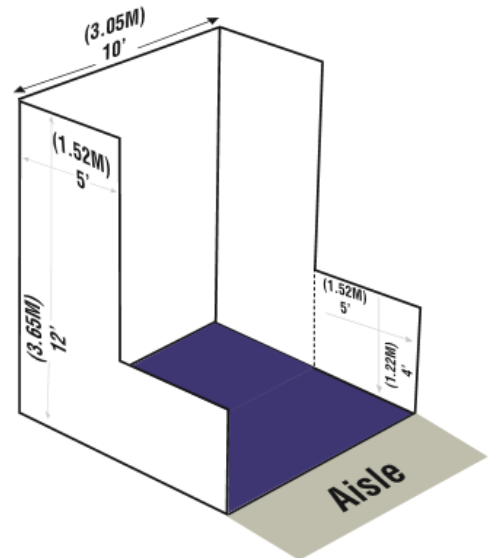
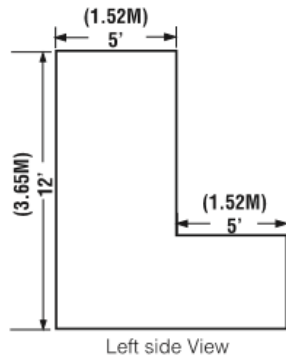
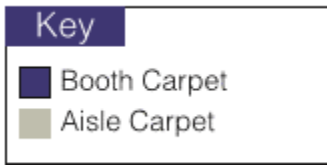

Standard

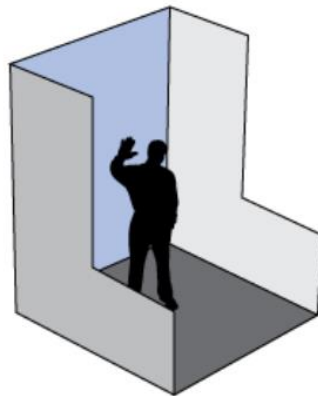

Perimeter

EXHIBITOR SPACE RULES AND SPECIFICATIONS

MINI ISLAND EXHIBIT SPACES

A Mini Island exhibit space is a narrow island type exhibit space comprised of one more or 10 ft-by-10 ft exhibit spaces. These exhibit spaces can be purchased in a row to make a 10x30, 10x40 etc. if the exhibitor abides by the rules below:

- Exhibitors are required to provide flooring for the totality of their exhibit space
- Mini Island (Multi-Story) are not permitted: One level only
- Max height = 12'
- Must be accessible from all 4 sides
- Hanging signs are NOT permitted
- Back walls and side walls that are visible must be finished
- Exhibitors are required to provide flooring for the totality of their exhibit space
- Stand drawings must be submitted in advance for approval by September 7th, 2021 to exhibit@printingunited.com

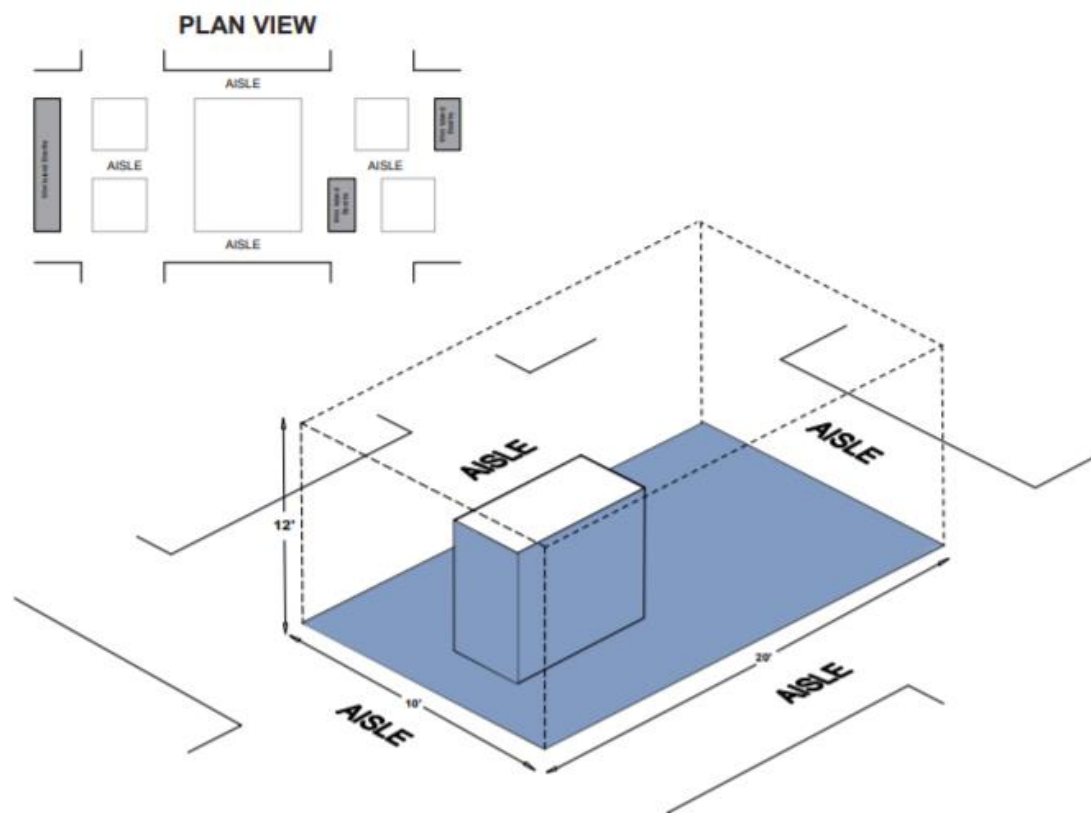

EXHIBITOR SPACE RULES AND SPECIFICATIONS

ISLAND EXHIBIT SPACES

An Island exhibit space is any size exhibit space exposed to aisles on all four sides. These exhibit spaces can be purchased if the exhibitor abides by the rules below:

- Exhibitors are required to provide flooring for the totality of their exhibit space.
- Max height = 18' (Including hanging sign) *unless a sponsor
- Must be accessible from all 4 sides
- Hanging signs are allowed
- Stand drawings must be submitted in advance for approval by September 7th, 2021 to exhibit@printingunited.com

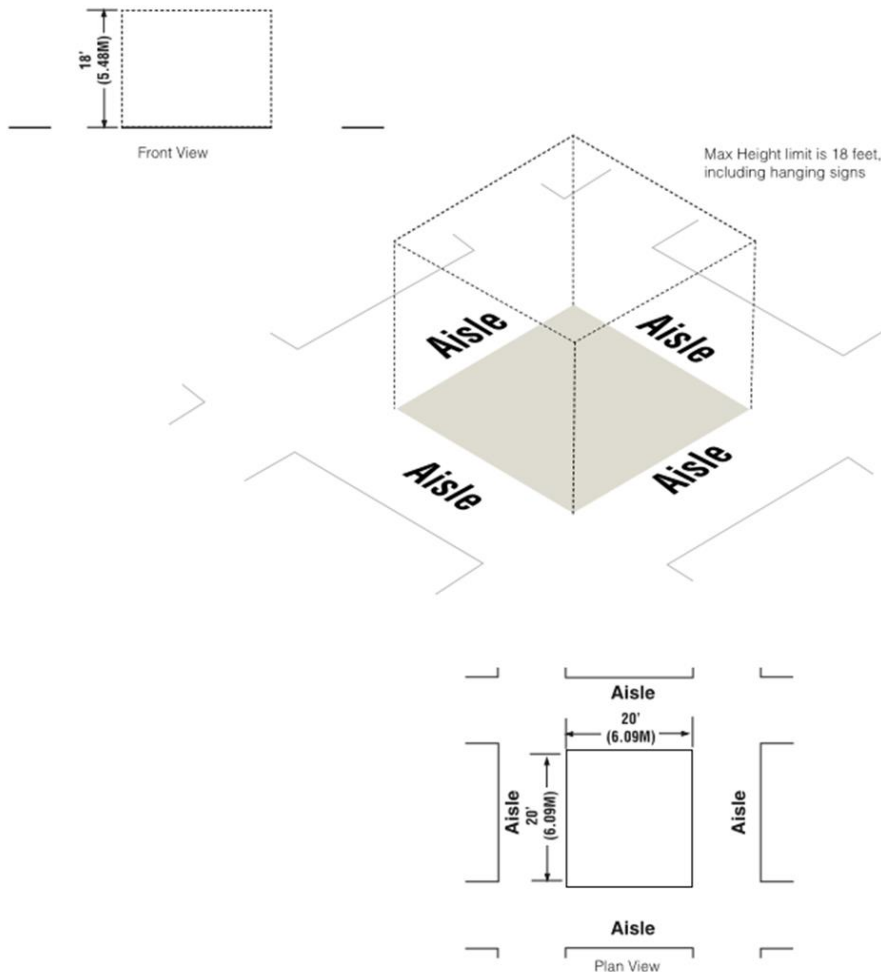

EXHIBITOR SPACE RULES AND SPECIFICATIONS

MULTI-STORY EXHIBIT SPACES

A Multi-story Exhibit is an exhibit space where the display fixture includes two or more levels. These exhibit spaces can be purchased if the exhibitor abides by the rules below:

- In many cities, a Multi-storied Exhibit requires prior approval by the exhibit facility, and/or fire marshal, as well as show management because it is considered to be a “structure” for building purposes
- Stand drawings must be submitted in advance for approval by September 7th, 2021 to exhibit@printingunited.com
- Fire extinguisher(s) and smoke detector(s) will often need to be included in the overall design

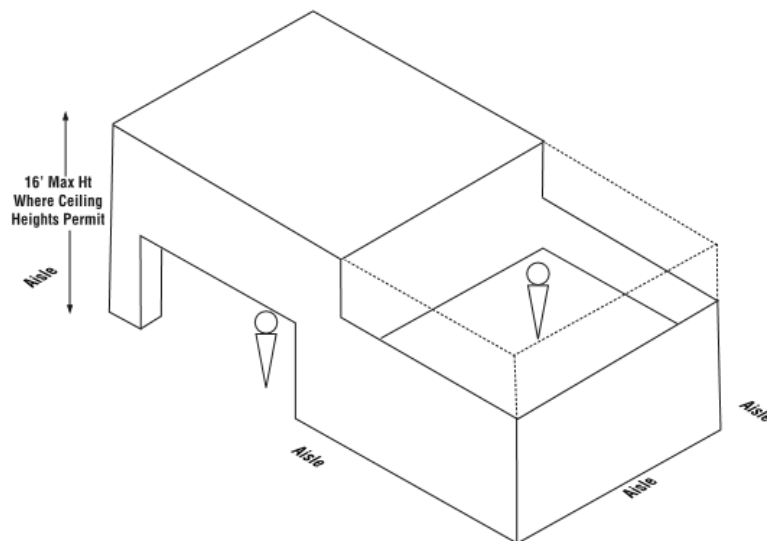
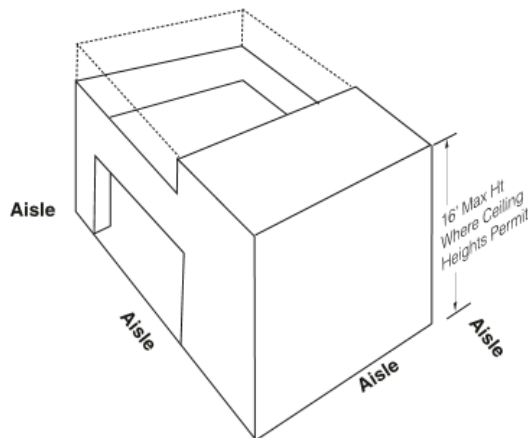



EXHIBITOR SPACE RULES AND SPECIFICATIONS

MACHINERY

All machinery and other large products must be set back from the aisles a MINIMUM of 12 inches (0.30m) for safety. Exhibitors are required to place equipment in such a manner that printed samples do not overflow into the aisles.

****Applies to all exhibit spaces planning to exhibit machinery of any kind.**

SPONSOR HANGING SIGN HEIGHT VARIANCE

Title Sponsors: Maximum height limit is 24'H to the top of the sign

Diamond Sponsors: Maximum height limit is 22'H to the top of the sign

Platinum Sponsors: Maximum height limit is 20'H to the top of the sign

Gold Sponsors: Maximum height limit is 20'H to the top of the sign

**** Applies to Island, Split Island and Peninsula exhibit spaces**

REQUIREMENTS FOR ALL EXHIBITORS

- Exhibitors are required to provide flooring for the totality of their exhibit space
- No end caps are allowed
- Tents are allowed in perimeter exhibit spaces ONLY
- Balloons are NOT permitted in any exhibit space
- Hanging signs are only permitted in certain exhibit types and hanging height varies
- Back walls and side walls that are visible must be finished